



*A material as diverse
as nature itself ...*



Not simply a material,
just simply amazing.

What it is and what it can do:

- // Material with high wood content – no PVC
- // Resistant surface
- // Coloured material
- // Solid products – no hollow section
- // Amazingly thin – highly resilient
- // Pleasant barefoot feeling – excellent surefootedness
- // Low brittleness, does not splinter
- // Suitable for toys according to EN 71-3
- // Resistant to chlorine and salt water
- // Simple processing just like wood
- // Systematic laying



In using **GCC (German Compact Composite)**, a wood-polymer material has been developed that is a true all-rounder. The composite primarily consists of **75% wood fibres** that undergo a patented process in order to supplement them with environmentally-friendly additives and polymers. The **“Made in Germany”** material is **free from PVC** and is highly versatile. Thanks to their high resilience and low thermal expansions, GCC products always remain in top shape. As our material is wood-based, natural processes change the colour and feel over time. We deliberately refrain from chemical sealing and, instead, rely on the ability of the natural product to protect itself. Over 15 years of experience and development speak for the material; we don't make any promises we can't keep!

- // Climate-neutral production due to lower CO₂ emissions
- // Conserving and preserving valuable raw materials
- // Enduring user experience
- // Creating a safe and healthy environment in the home
- // Our products meet the criteria for sustainable building and green building conformity with the DGNB System, LEED® and BREEAM®

POWOLIT

Hard shell, many cores. **POWOLIT** is a sub-type of GCC and combines the best of three worlds. In addition to wood and polymers, POWOLIT is also supplemented with **stone granules** in order to create a harder surface. This harder surface makes the material even **stronger and more resistant to stains and loads compared** to conventional wood materials. POWOLIT is a natural, changing material. The colours of the products will become lighter over the course of time and obtain visually appealing accents.





The "Earth Overshoot Day" serves as an annual reminder that humanity has already used up its entire resources budget that was meant to be for the current year. This was 22 August in the year 2020. The 31 December 2020 is however the target and zero mark for a secured future. A continual growth in consumer demand results in an increasing consumption of resources. The results of this are complex and irreversible environmental damage that has been visible for a long time on a global scale.

In order to reduce the size of the ecological human footprint, it is important that material cycles are closed and that materials can be reintroduced to the production of new products at the end of their long life cycle.

Our understanding of sustainability



Closed materials cycle

If one thing is in our genes, then it is the Cradle to Cradle® principle. It describes a materials cycle, in which products or raw materials circulate within recurring cycles. We have been installing a special returns system since 2005 in order to ensure that our GCC wooden material products can be used. This enables us to retain and use existing material resources without a change of quality. This enables us to expand and produce construction productions that conform with the highest quality standard – without additional consumption of new natural raw materials.

You will find returns dealers here: www.torrotimber.com/en/stockists



GCC conforms to Cradle to Cradle Certified™ Gold Standard*. Our GCC (German Compact Composite) material has been awarded the Cradle to Cradle Certified™ Gold. The certification is awarded by the Cradle to Cradle Products Innovation Institute. This means that our GCC material has received the confirmation that is both **human and ecotoxicologically harmless as far as all of the contents are concerned** at a global level of quality. The ecological evaluation of the integrated water management and the climate-neutral energy concept during production and the high level of social standards at our production site in Germany round off the comprehensive material and process evaluation in an integrated manner. GCC is therefore conforming with the highest eco-effectiveness standard.

	BRONZE	SILVER	GOLD	PLATINUM
Test material health				✓
Recyclability			✓	
Renewable forms of energy and CO ₂ management			✓	
Water management			✓	
Social justice			✓	

The certification proves that our products make a contribution to the positive sustainability evaluation of buildings.

* Cradle to Cradle Certified™ Gold, Version 3.1, Renewal 27 Aug 2022. For more certification information, go to www.torrotimber.com/en



Simply decide.
Plan simply.

Tailor-made for outdoor areas

Transform your garden area into a place of well-being with durable, easy-to-maintain and unique products. With the aid of the catalogue and the online planner, you can find suitable products and materials for your project and quickly and easily plan the implementation of it. Our range of boards, privacy screens and fences boasts a series of shades, structures with a wood appearance as well as the most diverse formats meaning that you can design your outdoor area completely in accordance with your demands and personal taste.



Simply plan online: planner.torrotimber.com/en

Allow dreams to come true. Simply design your outdoor area from the comfort of your own home. Whether to visualise initial ideas or to implement concrete plans, a few clicks is all it takes to learn what material you need and obtain respective plans and assembly instructions.

Please use the following link to discover where you can purchase torroTIMBER® as well as the accessories.
www.torrotimber.com/en/stockists



No more splinter worries!



Dolomit¹⁶

16 mm thick deck board, in two colours, 193 x 3000, 4000 or 5000 mm, gap width 5 mm

- XL**
extra wide
- multicoloured
- narrow 5 mm gap
- anti-slip R10

* The figures illustrate an example of the colours available for delivery and their natural colour maturation process

		After laying
		After 1-2 months*
		After 6-8 months*

Brown **Grey**



The extra wide deck board with a vivid interplay of colours and wood character

Do you appreciate the visual appearance of wood and the unique colour gradient that the natural product is able to provide? Then our Dolomit16 board in brown or grey is the right choice for you! The structured, polished surface as well as the gentle interplay of colours ensure a harmonious concept. Introduce a wood character to your terrace and beneath your feet.

- // Surface: Structured with colour gradient and polished
- // Can be laid on one side
- // Gap width: 5 mm (± 0.5 mm)
- // Colour-resistant
- // Free from dangerous splinters
- // Solid and completely coloured
- // Sustainable
- // High surface hardness
- // Material: **GCC**

The figure illustrates the torroTIMBER® Dolomit16 product in brown



Great feel.
Smart look!



Glacier¹⁶

16 mm thick deck board,
in two colours, 193 x 3000 or 4000 mm,
gap width 8 mm

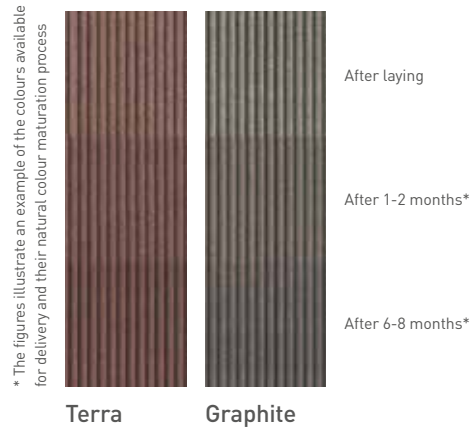
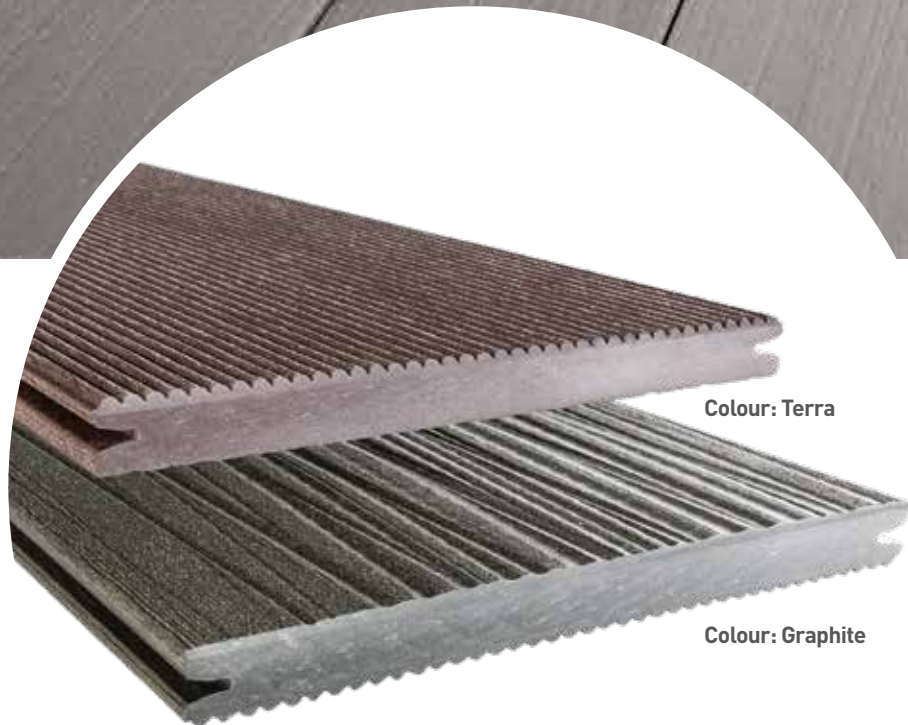

Colour: Terra

Colour: Graphite

The extra wide deck board with wooden character or finely corrugated design

Boards from the Glacier range are characterised by the mix of two varying sides. As it can be laid on both sides, the Glacier16 board boasts a finely corrugated surface on one side and a surface with wood character on the other. Randomly placed, curved structures give the surface a visual dynamic. The extra wide deck boards are available for purchase in terra and graphite and are a real eye-catcher as well!

- // Surface: Finely corrugated or structured
- // Can be laid on both sides
- // Gap width: 8 mm (± 0.5 mm)
- // Colour-resistant
- // Free from dangerous splinters
- // Solid and completely coloured
- // Sustainable
- // High surface hardness
- // Material: **GCC**

The figure illustrates the torroTIMBER® Glacier¹⁶ product in graphite



A wow factor every single day!



Trend¹⁶

16 mm thick deck board,
in two colours, 163 x 3000 or 4000 mm,
gap width 8 mm



The figure illustrates the torroTIMBER® Trend16 product in graphite

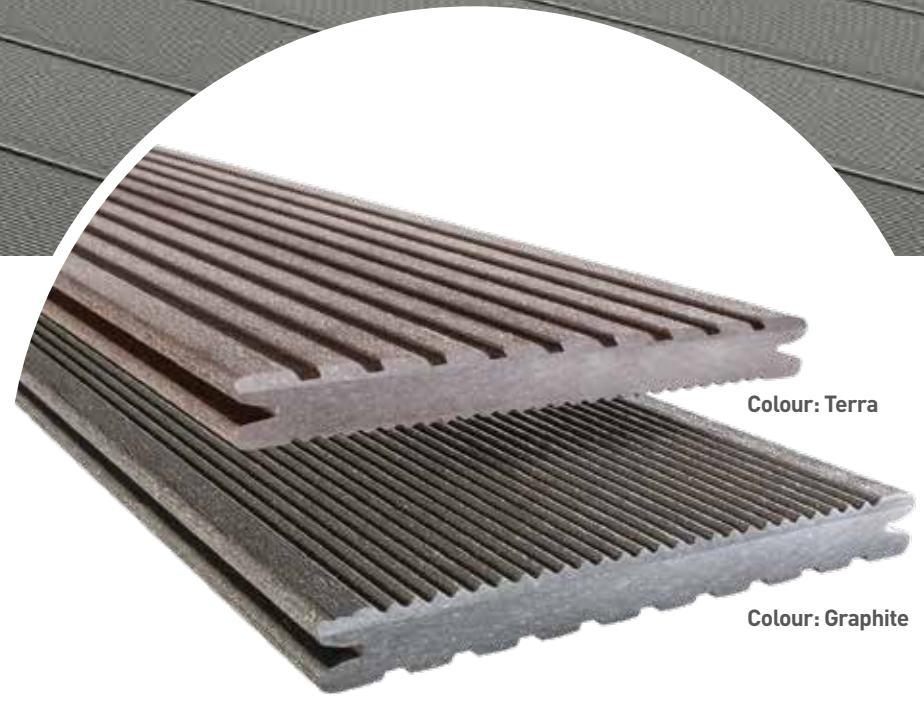
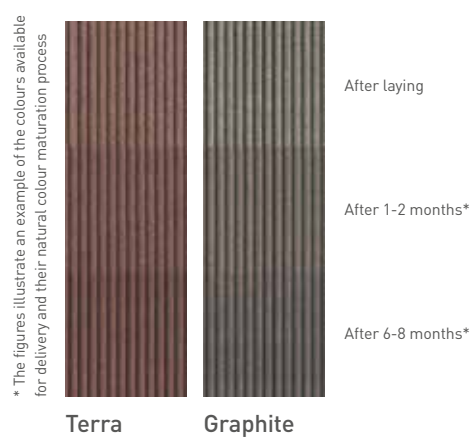

The wide deck board in grooved or finely corrugated design

One board, plenty of options. Thanks to its modern characteristics, our wide Trend16 deck board more than lives up to its name. It can be laid on both sides and is available in the covered terra and graphite colours. Finely corrugated on one side and grooved on the other. Irrespective of your decision, you will enjoy looking at the robust surface for a long time to come.

- // Surface: Finely corrugated or grooved
- // Can be laid on both sides
- // Gap width: 8 mm (± 0.5 mm)
- // Colour-resistant
- // Free from dangerous splinters
- // Solid and completely coloured
- // Sustainable
- // High surface hardness
- // Material: **GCC**

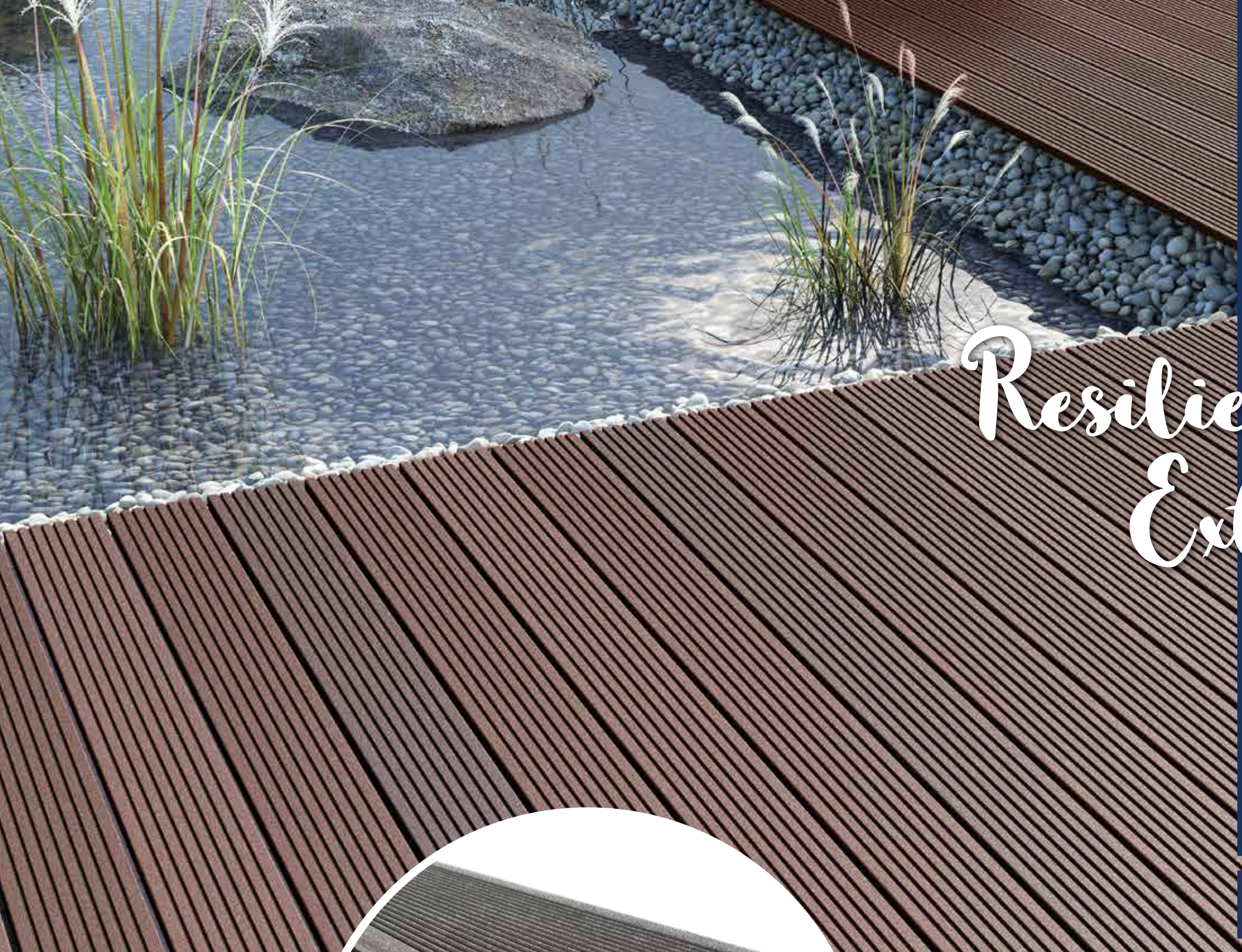

Resilient. Modern. Extra strong!



Trend¹⁹

19 mm thick deck board,
in two colours, 130 x 3000 or 4000 mm,
gap width 8 mm

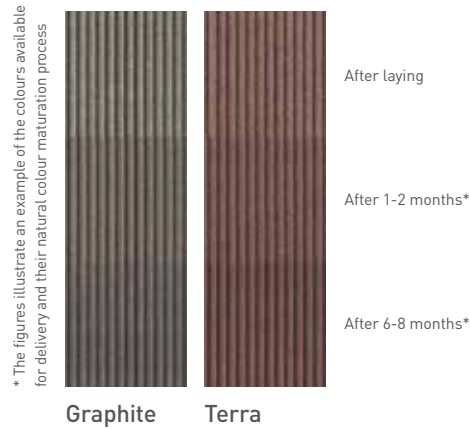

The narrow deck board in grooved or finely corrugated design.

With a thickness of 19 mm, our Trend19 board is a really tough cookie. The board has two different sides. One side boasts a fine corrugated design and the other side is grooved. Both sides can be laid in terra or graphite. By installing the colour resistant and anti-slip boards, you can upgrade your outdoor leisure time in a modern and safe manner.

- // Surface: Finely corrugated or grooved
- // Can be laid on both sides
- // Gap width: 8 mm (± 0.5 mm)
- // Colour-resistant
- // Free from dangerous splinters
- // Solid and completely coloured
- // Sustainable
- // High surface hardness
- // Material: **GCC**

The figure illustrates the torroTIMBER® Trend19 product in terra



Classic appearance, new advantages!



Dolomit¹⁹

19 mm thick deck board,
in two colours, 145 x 3000 or 4000 mm,
gap width 5 mm

- 
multicoloured
- 
easier
to maintain
- 
anti-slip R10
- 
narrow
5 mm gap
- 
flame
retardant

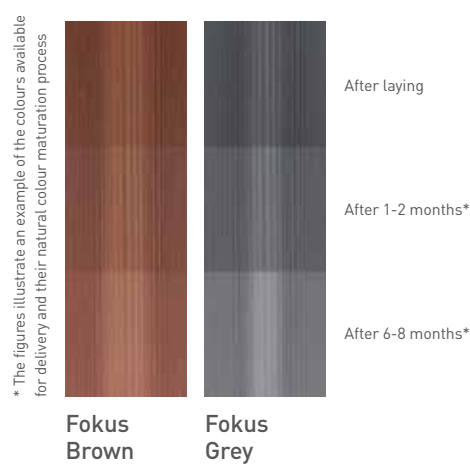
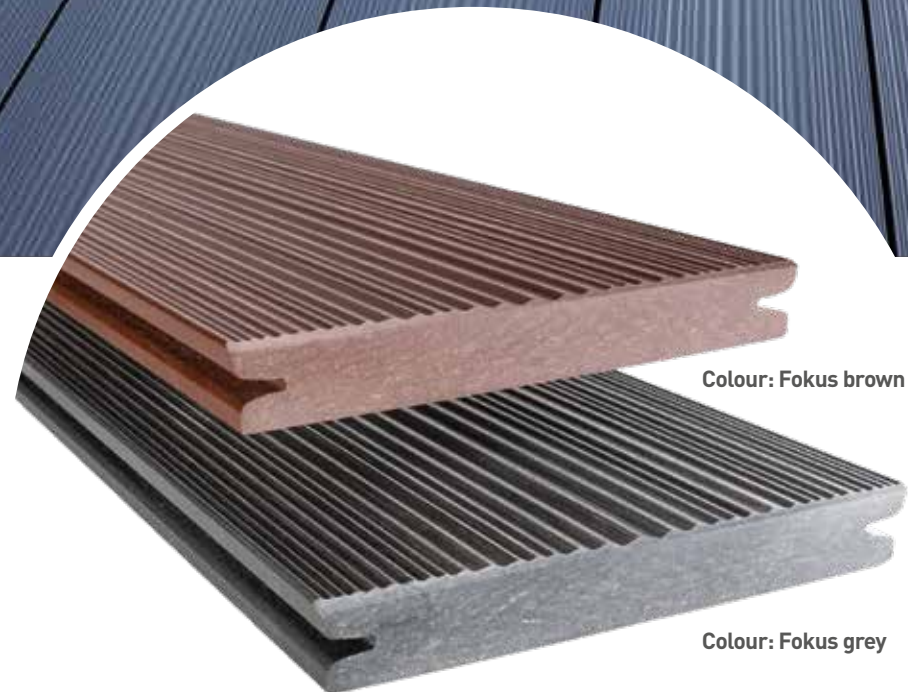

Colour: Fokus brown

Colour: Fokus grey

The classic deck board with natural colour gradient and sealed surface

The Dolomit19: Classic, premium and robust. The board with a corrugated, matt surface is available in either Fokus brown or Fokus grey. The utilised POWOLIT material strengthens the board surface. It is sealed, easier to maintain and flame retardant. The structure and natural colour gradient turns your terrace into a pleasant oasis full of comfort.

- // Surface: waved with colour gradient and matted
- // Can be laid on one side
- // Gap width: 5 mm (± 0.5 mm)
- // Colour-resistant
- // Free from dangerous splinters
- // Solid and completely coloured
- // Sustainable
- // Extremely high surface hardness
- // Material: GCC - POWOLIT

The figure illustrates the torroTIMBER® Dolomit19 product in Fokus grey



The tough lightweight!



Trend²⁵

25 mm thick deck board,
in two colours, 138 x 3000 or 4000 mm,
gap width 8 mm

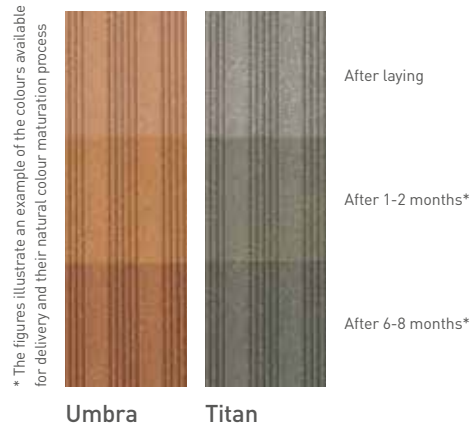
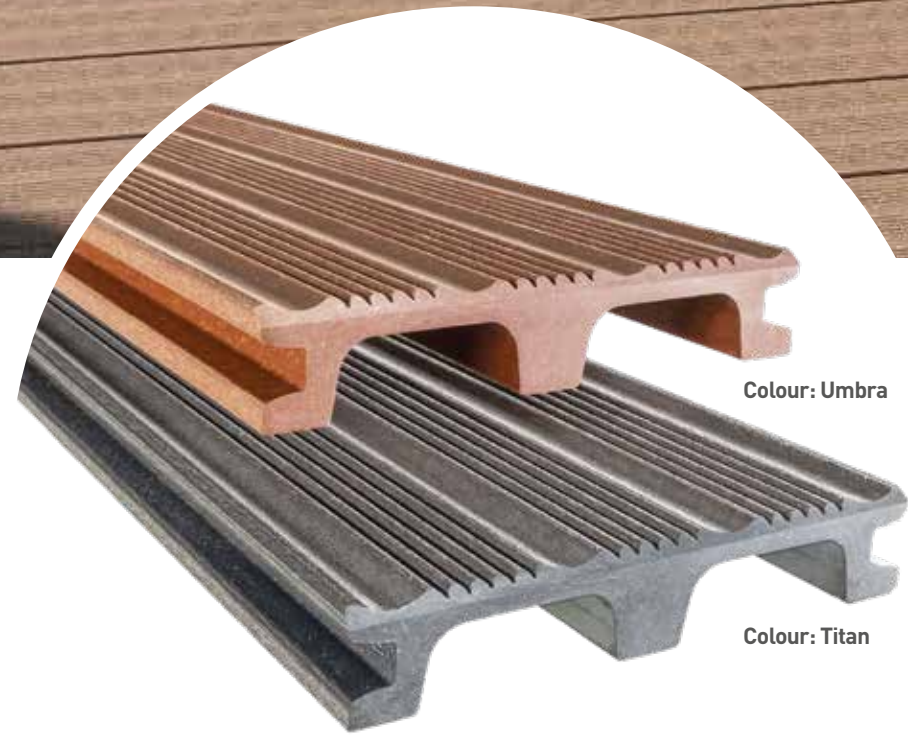

The extra light deck board in a strong format and light design

The Trend25 board is the lightweight of our product range. The unique selling point of this product is the material recesses that are utilised in order to reduce weight. However, this does not make the Trend25 a weakling! The board surface is partially corrugated and available in the warm natural umbra and titan tones. Create a pleasant atmosphere in your outdoor area.

- // Surface: Partially corrugated
- // Can be laid on one side
- // Gap width: 8 mm (± 0.5 mm)
- // Colour-resistant
- // Free from dangerous splinters
- // Solid and completely coloured
- // Sustainable
- // High surface hardness
- // Material: **GCC**

The figure illustrates the torroTIMBER® Trend25 product in umbra



A board with format!



Dolomit¹⁹

Deck board, 19 mm thick, in three colours, 245 x 3000 or 4000 mm, gap width 5 mm

NOW NEW AS A DECK BOARD!



- XXL**
extra wide
- droved surface
- easier to maintain
- anti-slip R10
- narrow 5 mm gap
- flame retardant
Cfl-s1

The artistically ridged surface for terraces with a strong character

The Dolomit19 deck board is produced in an imposing format using the POWOLIT material. Thanks to the unique combined characteristics of wood and stone granules, the terrace floor is stylish in terms of its appearance whilst also being robust in terms of its substance. A ridged and matt surface provides the boards with a certain something. No more obstacles in achieving a terrace that boasts a strong character whilst also being easy to maintain.

- // Surface: Droved and matted
- // Can be laid on one side
- // Gap width: 5 mm (± 0.5 mm)
- // Colour-resistant
- // Free from dangerous splinters
- // Solid and completely coloured
- // Sustainable
- // Extremely high surface hardness
- // Material: **GCC - POWOLIT**

The figure illustrates the torroTIMBER® Dolomit19 product in ecru

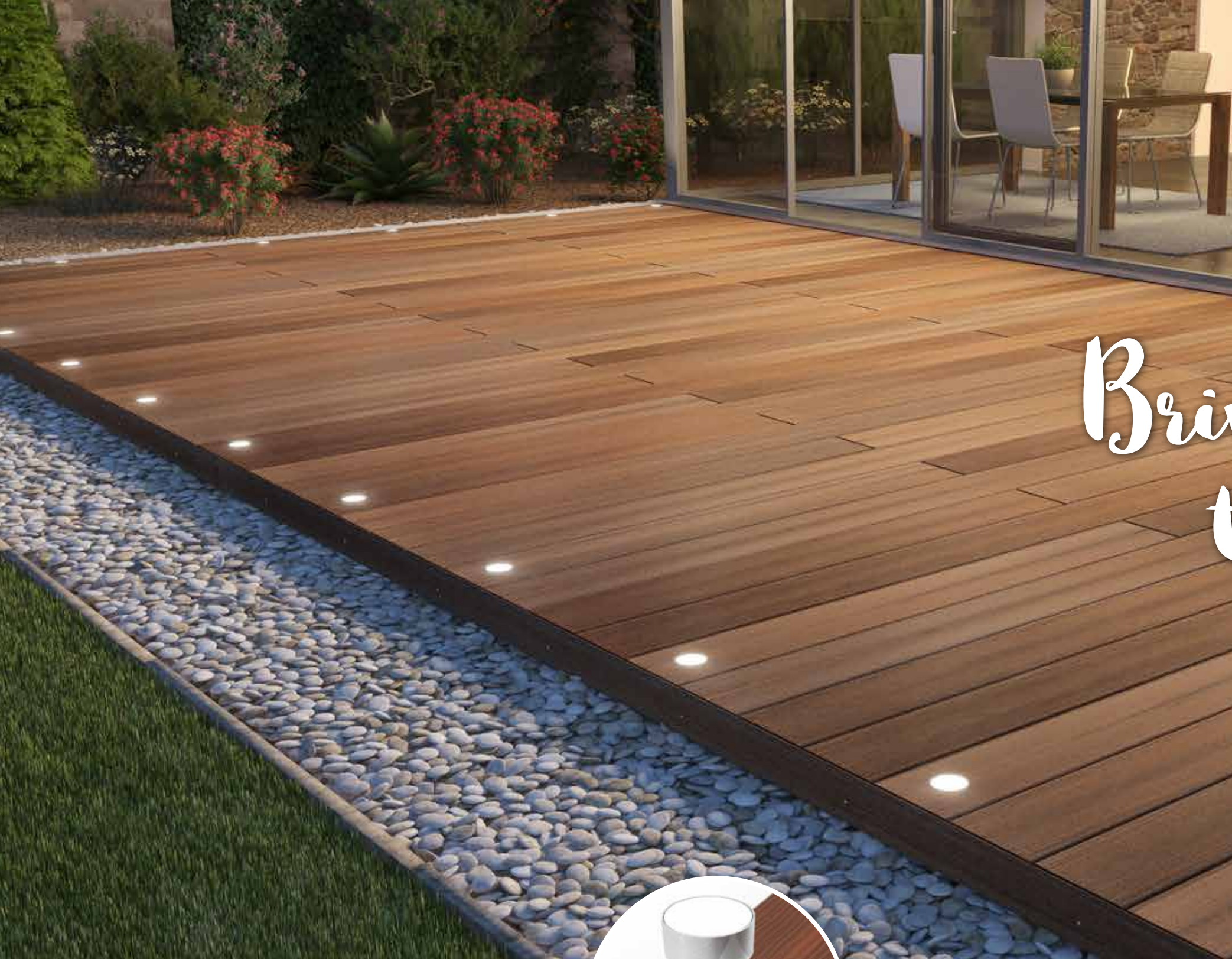

Brings light into the darkness!



Light System

LED spot set, IP67 lighting
 Ø 34 mm (0.25 W) or Ø 60 mm (0.5 W)

The figure illustrates the torroTIMBER® Dolomit product in brown

Item overview



LED mini spot
 Ø 34 mm (0.25 W)
 10 lumen



LED maxi spot
 Ø 60 mm (0.50 W)
 28 lumen



Radio control
 with remote control



Power pack 40 W



2-way distributor



4-way distributor



1/3/6 m extension



The dimmable LED spots in a pleasant warm light tone

The warm light emitted by the torroTIMBER® spots immerses your deck in a wonderful atmosphere. Whether spending mild evenings together with friends or enjoying a romantic dinner on your deck: torroTIMBER® light system charmingly emphasises these valuable moments. The LED lighting allows decks of all sizes to be upgraded with lights. Make use of your deck, no matter what the time of day!

- // 24 Volt DC IP67
- // Easy to assemble
- // Dimmable via remote control
- // Can be greatly expanded for radio control
- // Can be individually controlled
- // Scope of use: Private and commercial
- // Material: **Stainless steel spots**

Board overview

The torroTIMBER® boards are just like nature - multifaceted and repeatedly have a surprise in store. The warm muted colours generate a unique feel-good factor and the versatile structures bring a liveliness and authentic details to your deck. The natural and sustainable wood ingredients are resistant and strong when exposed to external influences, thus enhancing your outdoor area for a long time to come, until it can be provided with a new lease of life if it is returned to the production process for recycling.

Dolomit 16x193



structured and polished

Glacier 16x193



finely corrugated

structured

Trend 16x163



finely corrugated

grooved

Trend 19x130

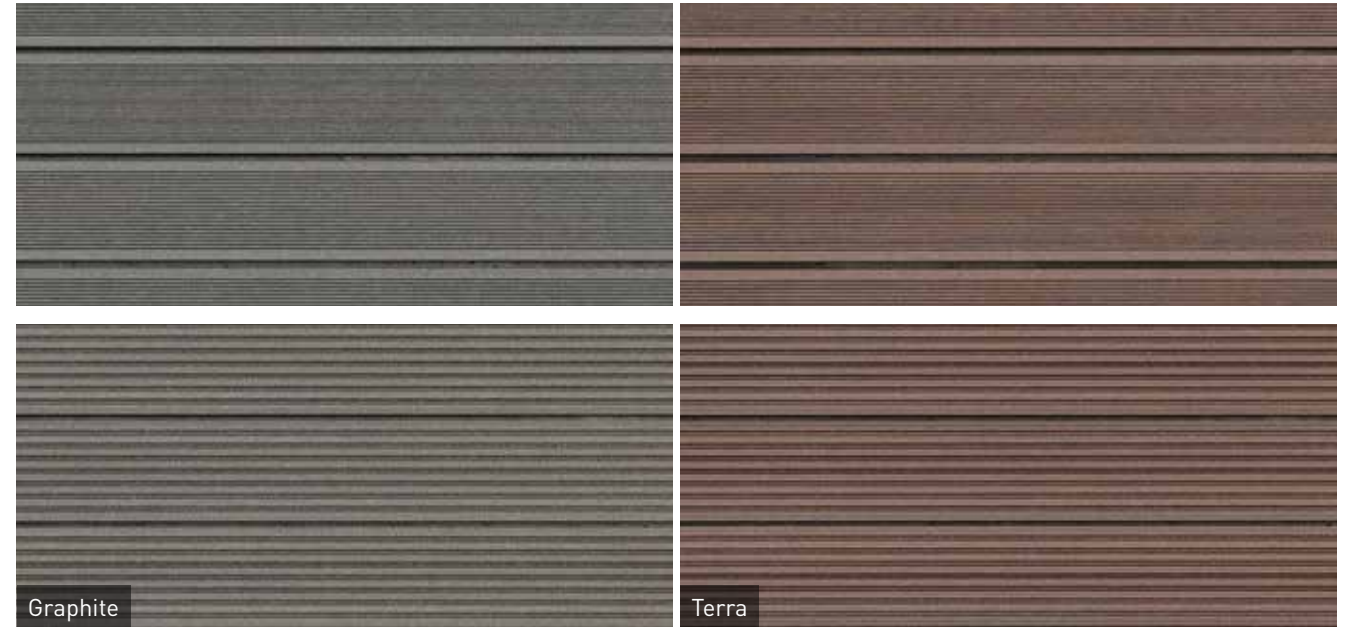

finely corrugated

grooved

Dolomit 19x145

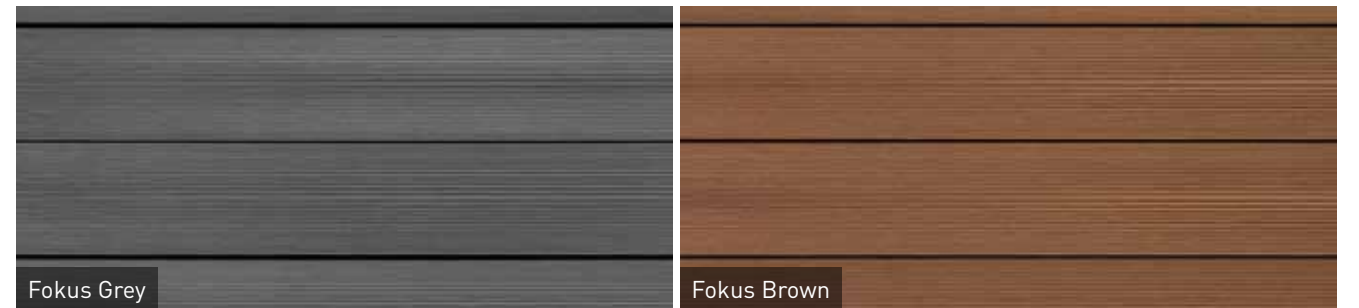

waved and matted

Trend 25x138

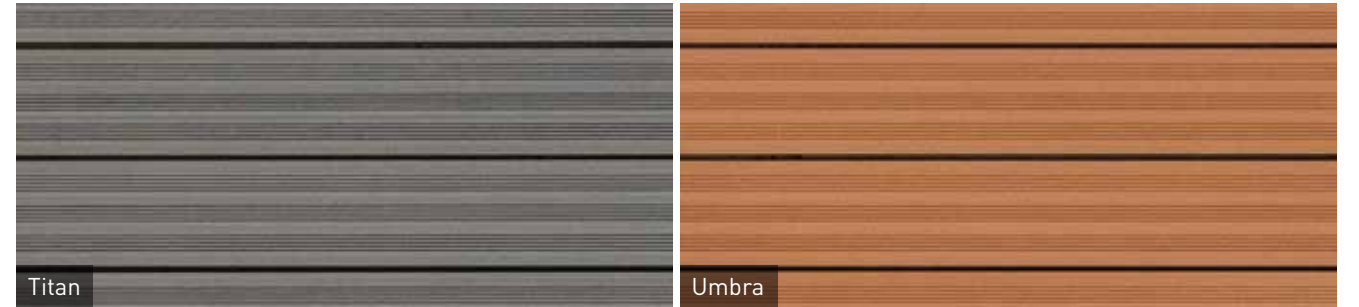

partially corrugated

Dolomit 19x245



droved and matted

Simple assembly

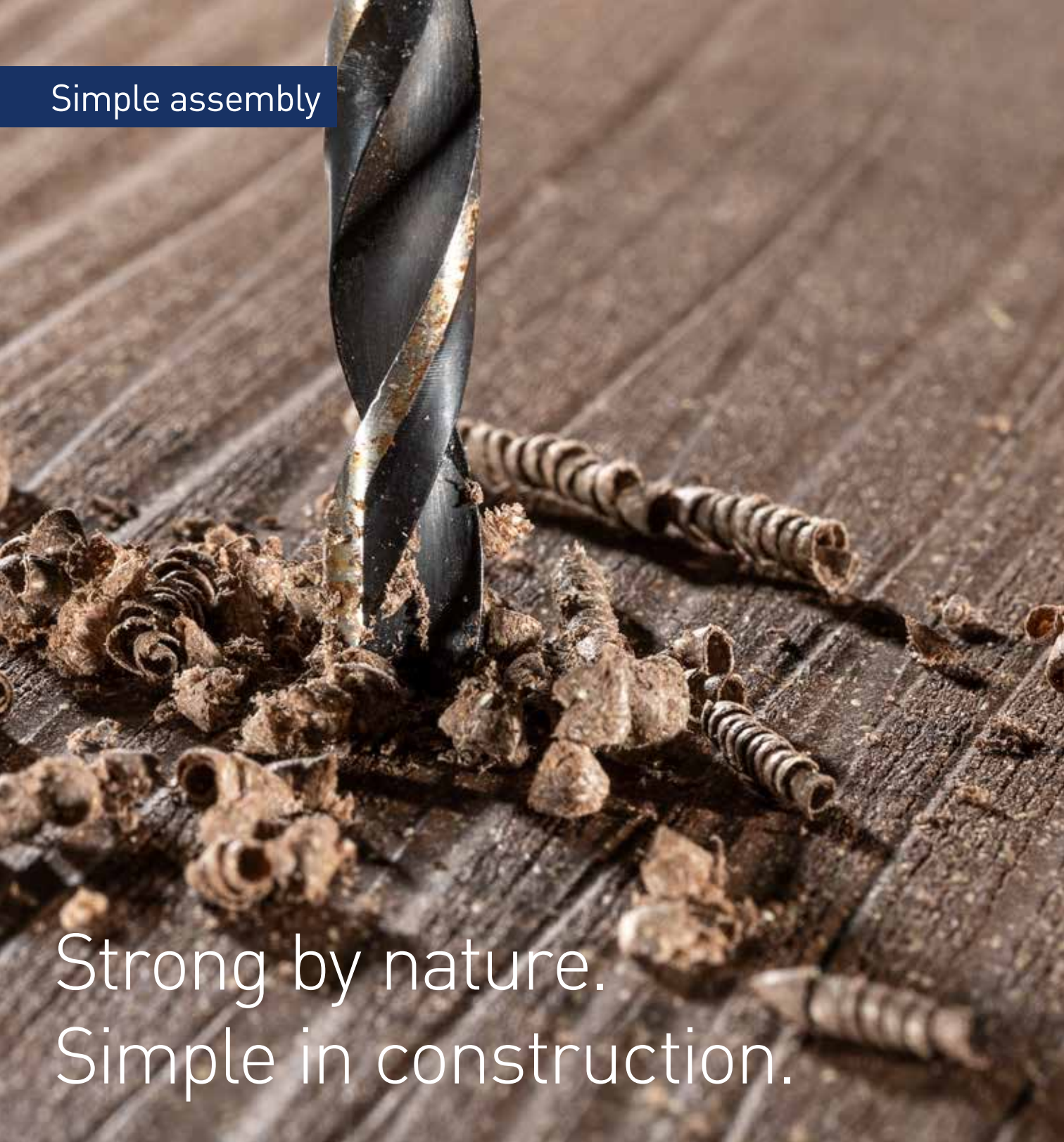

Strong by nature.
Simple in construction.

Simple assembly for all structure types

We want you to enjoy your deck for a long time. Only use original torroTIMBER® parts and observe our processing recommendations to ensure that our warranty does not become void.

Coordination with the manufacturer must take place and respective approval must be obtained in the event of special structures that deviate from these processing recommendations or the online planner in order for any potential warranty claims to be accepted.

Setup could not be any easier

- // Avoid contact between the construction elements.
- // Ensure that the subsoil is firm and has a good load bearing capacity. For applications that require an official technical approval, a static sufficiently measured, bearing and walkable foundation as a support for torroTIMBER® boards /subconstructions is also required.
- // When using metric screws, all of the holes should be pre-drilled so that the part that is to be fixed in place, is 2 mm larger and the retaining drillhole is exactly 0.5 mm smaller than the diameter of the screw!
- // Observe the minimum clearances of the expansion joints so that the construction can expand without force if necessary and a sufficient amount of ventilation from underneath is ensured.
- // Cutting the longitudinal side of the boards may result in board offset.
- // Do not lash down or brace the deck during construction.

- // Rod-shaped components that are to be screwed onto a rigid substructure, always have the fixed point in the centre and floating outwards so that thermal expansion and an expansion due to an absorption of water can be compensated for.
- // Distance between the deck board and all fixed components: 20 mm
- // Do not fill cavity spaces between the level surface of the gravel and subconstruction elements.
- // Recommended minimum gradient of 2% in the longitudinal direction of the boards.
- // Maximum deck board protrusion over the last subconstruction is 50 mm.
- // Production-related dimension tolerances regarding length, width and thickness are to be taken into account during assembly and the dimensions on the construction must be examined once again.
- // The planks are to be cut off at right angles and then to chamfer.

Simply pay attention to the laying direction

Lay all of the boards in the same direction in order to obtain a homogeneous surface effect. This direction is shown by an arrow in the board groove or on a label on the board. Mix the boards prior to laying. This allows the slight differences in the colour of the boards to emphasise the natural appearance.



Mechanical characteristics

Three-point bending	Boards
Support clearance:	360 mm
Test speed:	20 mm/min
Breaking load:	3200 N*

* 3200 N corresponds to ≈ 320 kg/board with a maximal clearance of 400 mm from the substructure.

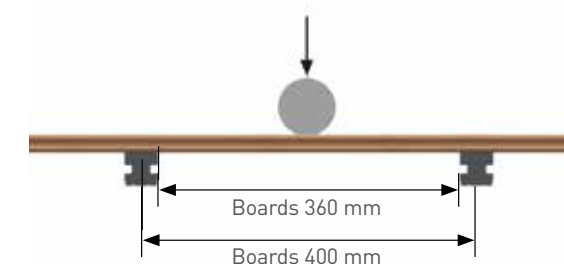

Production-related dimension tolerances

	Specification	Tolerance field	Dimension	Measurement point	Permitted dimension change after water absorption* guaranteed values	Remark
Profile length	3000 / 4000 / 5000 mm	± 0.0/+ 10.0 mm	Length	Maximum value	Board length 3000 mm ≤ 9.0 mm Board length 4000 mm ≤ 12.0 mm (≤ 3 mm/m) Board length 5000 mm ≤ 15.0 mm	Distance from other fixed components, min. 20 mm
Profile width	130 / 138 / 163 / 193 / 245 mm	- 2.0/+ 1.0 mm	Width max. 245 mm	Board, centre	max. ≤ 1.2 mm	
Profile thickness	16 / 19 / 25 mm	- 1.0/+ 1.0 mm	Thickness max. 19 mm	Board, centre	max. ≤ 0.5 mm	

* In the event of exposure to outdoor weathering and construction executed in accordance with the construction manual

Simple processing



Simply cut.
Simply drill.
Simply grind.

Simple material processing

We have created a material that is extremely easy to maintain and is also resistant. Thanks to the material structure, products are as easy to process as is the case with wood. Whether cutting, drilling or grinding, modify the material as you see fit or as the situation demands.

Item overview for assembly on concrete edge stones



Construction beam
40 x 40 mm



Fastening screw for
subconstruction
7,5 x 92 mm



Connecting clamp



Rubber pad
100 x 60 x 20 mm
100 x 60 x 10 mm
100 x 60 x 3 mm



Locking clamp
(one-piece)



Edge clamp
(two-piece)



Groove bridge



Clip & edge clip
incl. screws



M6 x 40 mm screw in
order to screw short
deck board sections



Distanz Fix for the
creation of a heading
joint (5 mm/8 mm)



Arretier Fix for the height
locking of the butt joints
in a stretcher bond (5 mm
gap) for the deck board



Retaining band,
self-adhesive



M8 x 40 mm fastening
screw for the rhombus
profile as a closing strip



M8 x 80 mm fastening
screw for the rhombus
profile as a closing strip

Rhombus profile as a closing strip 81 x 20,5 x 4200 mm



Rhombus profile
Fokus Chocolate
Black for the
Glacier Terra
and Trend Terra
boards



Rhombus profile
Fokus Brown
for the Dolomit
Brown and Fokus
Brown boards



Rhombus profile
Fokus Grey for the
Dolomit Grey and
Fokus Grey, Gla-
cier Graphite and
Trend Graphite



Rhombus profile
Platin for
the Dolomit Platin
and Trend Titan
boards



Rhombus profile
Ecrú for the
Dolomit Ecrú
board



Rhombus profile
Jade for the
Dolomit Jade
board



Rhombus profile
Umbra for the
Trend umbra
board

Additional items for assembly with the ConStep system



ConStep
mounting plate



ConStep
double mount



ConStep
single mount



ConStep rubber pad
300 x 300 x 10 mm
300 x 300 x 5 mm
300 x 300 x 3 mm



Perforated band



ConStep
assembly clip

Assembly on concrete edge stones

In accordance with constructive wood preservation principles, we recommend to lay the boards with a minimum gradient of 2% in the longitudinal direction. As a result, the water can flow away, waterlogging and building damage is prevented and water stains are minimised.

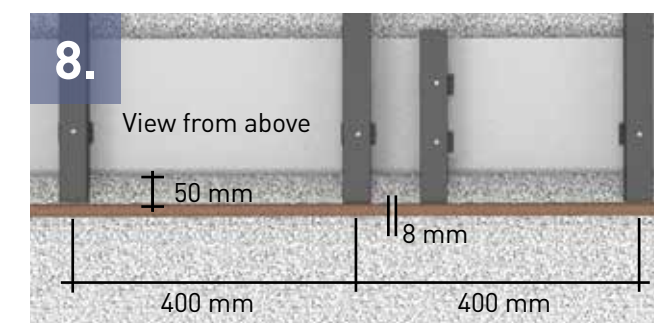
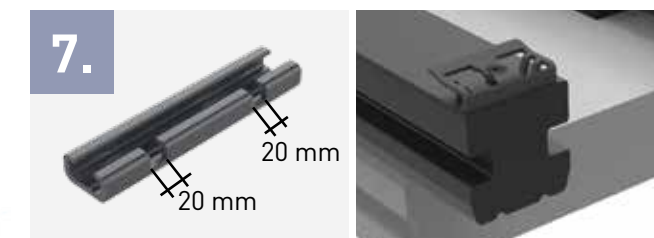
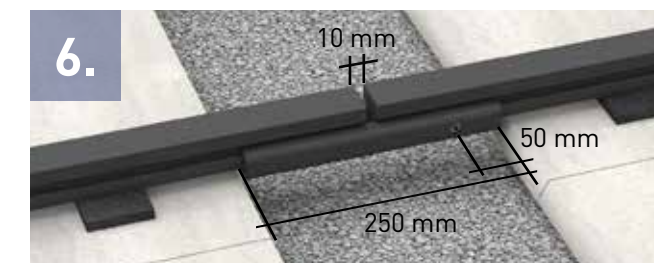

Preparation of the subsurface

1. Establish a soil formation with a gradient of 4%.
2. Whilst ensuring that it protrudes by 500 mm around the circumference of the terrace, create a ballast bed (including drainage) with a 2% gradient. Apply fine grit to the ballast bed with a 2% gradient.

Assembly of the subconstruction

3. Lay the concrete edge stones (100 x 25 x 5 cm) on a gradient gravel bed with a centre distance of 500 mm.
4. Equally space the construction beams (40 x 40 mm) transversely to the concrete edge stones (the groove is at the bottom), ensuring that there is a protrusion of 50 mm on the end face (see detail 8). Position two beams at the beginning and two at the end (axial dimension: 160 mm). Place 10 mm rubber pads underneath the construction beam and compensate for any gradient differences with additional rubber pads. Screw the construction beams around the entire edge of the terrace and the beams that the retaining band is mounted on, to the concrete slab. When laying the terrace herringbone style, the construction beams need to be screwed to the concrete slabs that are positioned underneath the beginning and end of the board.

5. If the terrace should be more than 3 m wide, the ends of the construction beam are always to be positioned offset and connected using the connecting clamp. The connecting clamp makes it possible to create terraces that are larger than 12 x 12 m without the requirement for structural expansion joints.
6. Cut the connecting clamp to 250 mm so that the beam joints are joined to each other and then screw tightly on one side (clearance of the joints: 10 mm).
7. Saw the connecting clamp to a width of 20 mm and a depth of 10 mm at the outer construction beam so that the rhombus profile can be used as a closing strip in the area of the screwed connection. The butt joint of the rhombus profile accommodate the butt joints of the subconstruction.
8. The butt joints of the rhombus profiles accommodate the butt joints of the boards in the direction of the board as long as the boards have been laid herringbone style. This necessitates the mounting of an additional piece of construction beam (320 mm long) in the area of the butt joints of the rhombus profiles.
9. Adhere retaining band to a construction beam that is located in the centre underneath the board. When using the Distanz Fix when laying herringbone style, the retaining band has to be adhered to each of the construction beams.

Assembly of the boards with clip

10. Chamfer the cut edges of the boards.
11. Place an edge clip at the beginning of the face of the construction beam so that it is flush with the beam, pre-drill to a depth of 3 mm and loosely fix in place using a screw (do not tighten yet).
12. Push the first board onto the positioned edge clip. Use the clip for the following boards, pre-drill to a depth of 3 mm and loosely connect it to the construction beam using the enclosed screws. Now push the next board against it until the clip is positioned against the groove. Tighten the clip applying the average torque after approx. 5 rows of boards have been laid. Repeat this until the last board but one has been laid.
13. After laying the last board but one, determine the width that is required for the last board and saw the construction beam to the required length so that it is flush. The construction beam has to protrude over the edge of the design beam by 10 mm so that the edge clip can be positioned as a final mounting.
14. Position the final board and fix the edge clip in place. Pre-drill a hole for the screw and screw in place applying an average torque.
15. Cut the boards to length at a right-angle at the face edge, ensuring that there is a protrusion on 15 mm. Maximum board protrusion: 50 mm. Chamfer the cut edges.

Mounting the rhombus profiles as closing strips

16. Leave a minimum clearance of 15 mm between the rhombus profile and the surface of the ground.
17. Screw the rhombus profiles maximum 60 mm from the ends and maximum 400 mm from each other and pre-drill true to the principles. When laying parallel to the boards, screw on using M8 x 40 mm screws so that they are flush with the end edge of the construction beam. Act in accordance with Detail 8 as regards butt joints.
18. When mounting at the face towards the boards, screw on using M8 x 80 mm fastening screw and use the corresponding nut as a spacer and in order to fix in place.

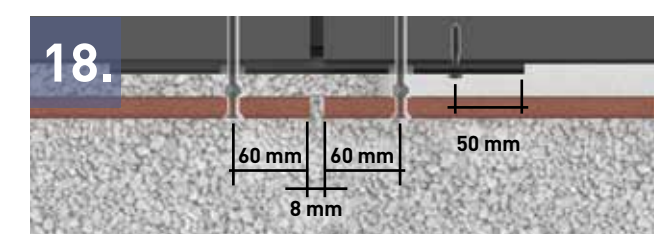

Assembly with ConStep system

Our sophisticated ConStep system is the best subconstruction for your torroTIMBER® terrace. The system components impress with their lightness, variable installation heights and ease in terms of laying. Single and double mounts are clicked into the ConStep mounting plate and form the base of the construction beams which will be applied on top.

Easily implemented variable installation heights

Our patented click system allows construction heights of between 98-143 mm (in steps) to be easily implemented.

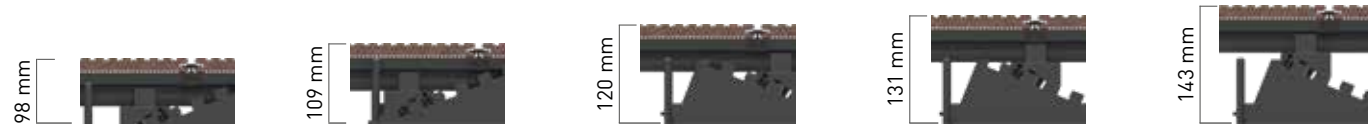

Preparation of the subsurface

1. Establish a soil formation with a gradient of 4%.
2. Whilst ensuring that it protrudes by 500 mm around the circumference of the terrace, create a ballast bed (including drainage) with a 2% gradient. Apply fine grit to the ballast bed with a gradient of 2%.

Assembly of the ConStep plates

3. In all of the ConStep mounting plate, click in the single and double mounts to the same height and centrally bond into place with a piece of retaining tape.
4. Position the ConStep mounting plate with double mount at a distance of 80 mm to the house wall and a maximum alignment of 500 mm to the next ConStep mounting plate with double mount.
5. Position the ConStep mounting plate with single mount with max. 400 mm dimension between axes in the next row.
6. Conclude the end of the deck using a further ConStep double mount. Click the subconstruction into place.
7. Minimise protrusions. In order to do so, turn the ConStep mounting plate where necessary.
8. Using the ConStep assembly clip, reinforce the entire subconstruction with perforated band in a crosswise manner.

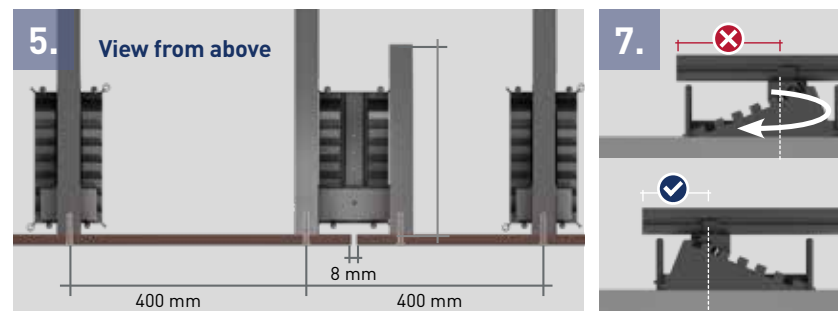
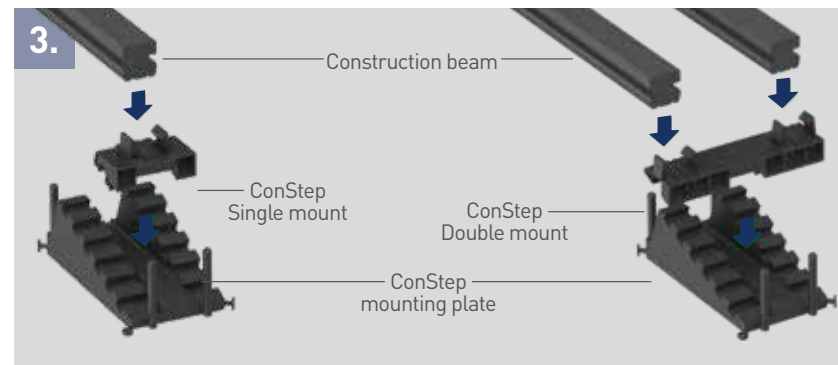

Continue as described under mounting of the subconstruction concrete edge stone items 4 to 9 on page 30.

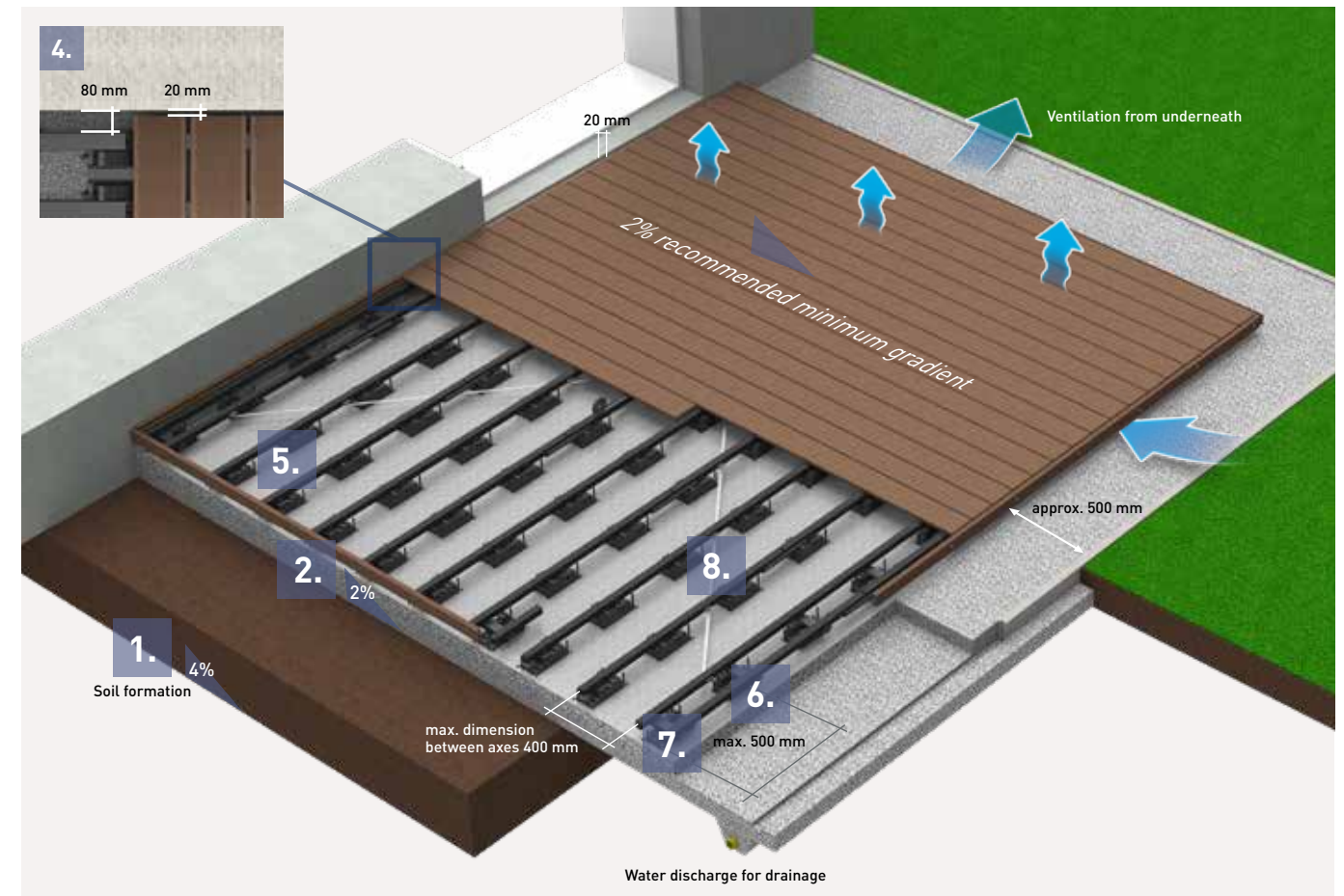

Assembly of the board with locking clamp

9. Saw into the construction beam from the side from which the boards are to be laid. This must be performed 12 mm from the edge, to a depth of 5 mm and to a width of 2 mm. Position the edge clamp in this groove and, using pliers, fix together with the construction beam and push the board into the edge clamp.
10. Place the locking clamp onto the construction beam, fix into place using pliers and push into the deck board groove. Using the supplied screw, engage the lock lips into every 3rd deck board row on the construction beam.
11. After the penultimate board, determine the required width for the last deck board and saw the construction beam to length so that it is flush. In doing so, please note that the construction beam must protrude by 12 mm from the last board (for fixation of the edge clamp).

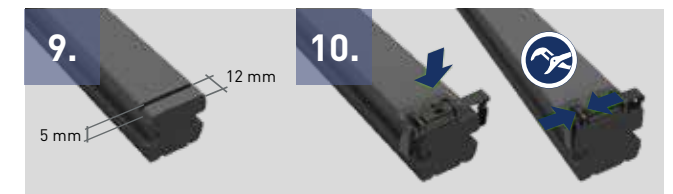

Mounting the closing strips: see Items 16 and 18 when mounting with concrete edge stones

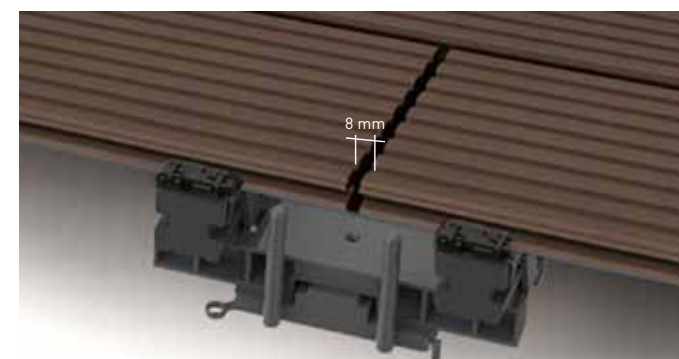

Herringbone pattern installation with double subconstruction beam

Assembly with the example of ConStep double mount

Clearance between the boards at the end edge: min. 8 mm. Use the Distanz Fix component for an ideal gap appearance. At the joint of two boards, use a construction beam at the start and end of the board respectively. Do not hit on a construction beam.

Simple terrace maintenance

Regular care minimises persistent deposits such as pollen, dust or the settlement of organic substances. We recommend cleaning the deck thoroughly at least twice a year (and more frequently if necessary). The outdoor temperature should be at least 15°C when cleaning the deck. Please proceed as follows when cleaning:

1. Brush away any dry, loose dirt from the terrace deck.
2. Sufficiently water the entire terrace deck and keep moist for at least 15 minutes.
3. Clean the terrace deck using a solid brush or scrubber.
If a deeper clean is required, please also use a surface cleaner with a rotating brush.
4. Thoroughly rinse with clear tap water and pull off with water.

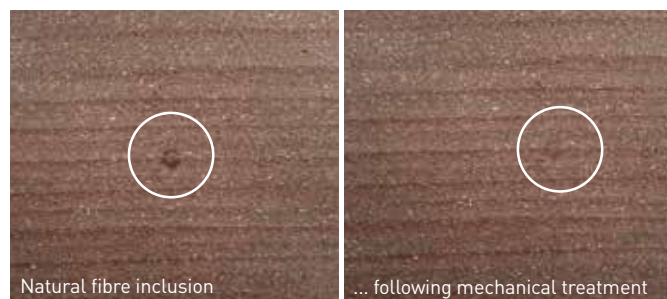

Simply real natural fibres

Due to the natural raw material, small inclusions of bast and natural fibres may occur. These fibres often rise to the surface after being subjected to weathering and water absorption. The majority of these inclusions will disappear once again over time if the terrace is used normally. They can also be mechanically removed if they are bothersome. The product will not be damaged.

Simply wait

Your terrace is full of life and that's a good thing! Don't worry about traces of use or instances of "polishing" that are caused by the furniture. Weathering usually causes traces of use on the deck board surface to disappear over time. So sit back and relax! However, if you do want to do something about it, just clean your terrace regularly. This ensures that fewer visible traces of use occur.



Simply clean with water

Everyone knows that it's not possible to control the weather. The formation of water marks as a result of precipitation or dust deposits are a natural consequence. They occur particularly frequently in the transitional area of covered areas as well as in uncovered areas. Unfortunately, these edges cannot be completely avoided. However, they are easy to remove with clear water. Regularly cleaning and maintaining the surfaces has a preventative impact against new water stains and reduces their occurrence over time.

Powerful cleaning with the GCC scouring powder

Use the scouring powder to thoroughly clean your severely soiled torroTIMBER® terrace surfaces. It does not include any tensides or other chemicals and it also does not pose a risk to groundwater. 2 kg of scouring powder suffice for approx. 20 m². Do not apply to sensitive surfaces or mask them in advance, do not use on co-extruded terrace decks. Cleaning with scouring powder is carried out between steps 3 and 4 of the terrace care instructions. You will find the instructions for use on the product label. The safety datasheet and the list of ingredients is provided at: www.novo-tech.de/service

Construction Timber Range

The new torroTIMBER® construction timber range is made for all kinds of ideas, and captivates the imagination with its great flexibility. Numerous outdoor designs can be created using the enclosed rhombus profile and the construction plank.

Rhombus profile

The rhombus profile can be used both as a stylish cladding element and as a closing strip to terrace decks and it is available in seven colours. The colours of the rhombus profile is assigned to a colour spectrum ensuring harmony with the chosen terrace boards. You can determine which profile best matches your terrace deck by going to page 29.

Construction plank

The construction plank is your key to infinite creativity. The construction planks are available in a total of nine colours so that they serve a customised implementation of garden elements and furniture. Everything is possible with construction timber, whether a sandpit, a raised gardening bed or a bench.



The large variety of colours in the construction timber range

Rhombus profile

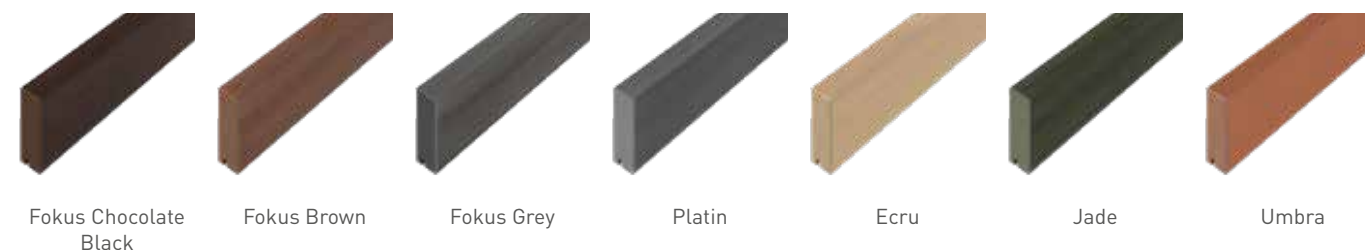

Construction plank



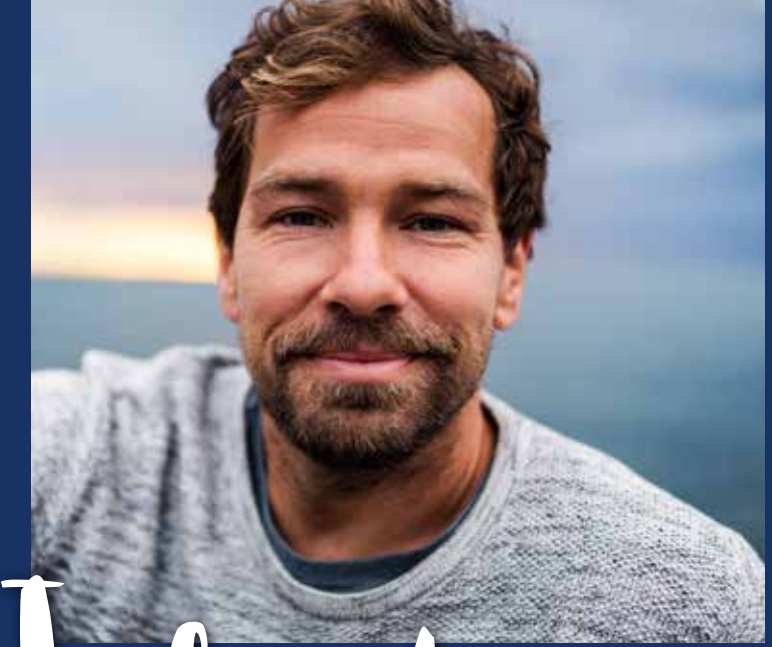

Infinite creativity



Construction plank

40 x 112 x 3600 mm, in nine colours



Colour: Terra

Colour: Graphite

Variety of colours

The construction plank is available in a total of nine colours.

You will find the entire variety of colours that the construction timber is available in on page 35.

The construction planks that match creative ideas

Made for free thinkers: the new construction planks as a part of the construction timber range! Classical or completely customised designs can be implemented in combination with the rhombus profiles. Innumerable creative ideas can find their space in your outdoor grounds on the basis of our innovative composition of materials. With a variety of nine colours, the construction planks are a perfect match to the look of your terrace and leave nothing to be desired.

- // Form: rectangular, rounded-off
- // Available in nine colours
- // Colour-resistant
- // No dangerous splinters
- // Solid and imbued
- // Sustainable
- // Material: **GCC**

The illustration shows the torroTIMBER® construction plank in the colour graphite (jetty) and the torroTIMBER® rhombus profile in the colour jade (shelter).



A profile with charm!



Rhombus profile

20.5 x 81 x 4200 mm, in seven colours, min. joint clearance 5 mm



Colour:
Fokus Chocolate Black



Variety of colours

The rhombus profile is available in a total of seven colours.

You will find the entire variety of colours that the construction timber is available in on page 35.

Item accessories



Stainless steel clip

Instructions

Mounting the rhombus profile:
www.torrotimber.com/en/downloads

The solid rhombus profile with its attractive colour gradient for stylish cladding

You can use the rhombus profile as a tasteful wooden cladding or as closing strips for your new terrace. The solid profiles in seven colours captivate with an attractive colour gradient and skilfully insert themselves in all environments. Fastening is possible both visible with screws and hidden with stainless steel clips. The rhombus profiles can also be mounted within a multiple field system with a max. axial dimension of 80 cm or in a single field system with max. 60 cm.

- // Surface: with a colour gradient, matted, with vascular rays on one side
- // Can be layed on one side, visibly screwed in place or invisibly mounted with stainless steel clips
- // min. joint clearance: 5 mm
- // Colour-resistant
- // Free from dangerous splinters
- // Solid and completely coloured
- // Sustainable
- // Material: **GCC- POWOLIT**

The figure illustrates the torroTIMBER® Rhombus profile product in Fokus chocolate black.



A fence in no time at all!



Bar fence "Blickfang"

- height and width individually adjustable
- can be erected at all angles
- slope-adapted installation possible
- 25 year guarantee against rotting in the ground

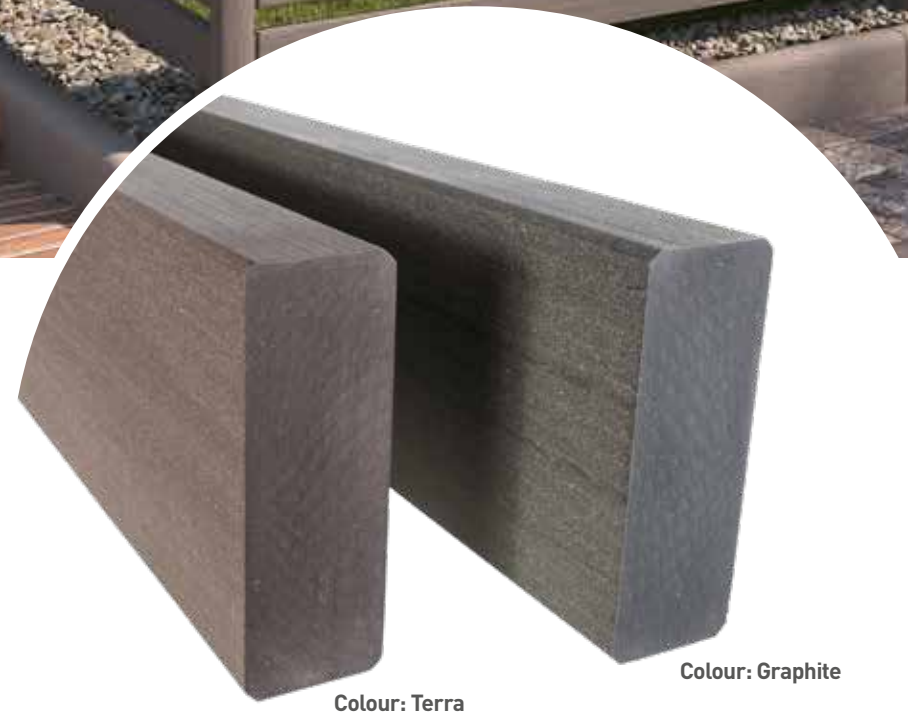

Colour: Terra

Colour: Graphite

The classic fence equipped with solid bars

With the torroTIMBER® bar fence, you can upgrade your garden with a decorative boundary manufactured from innovative material. Adapt it to your garden requirements: Thanks to flexible connecting elements that can be utilised, the solid bars can be installed in various ways and at different heights. Matching doors and gates are also available on top as an optional design! The fixed anchoring of the post with the foundation means that the bar fence is equipped for all types of weather. Not only that: You don't need to worry about the posts rotting in the ground for 25 years – that's our guarantee!

- // Form: Square, curved
- // Dimensions: 40 x 112 mm
- // Length bars: 178.6 cm or 360 cm**
- // Pre-assembly also available for order
- // Matching doors and gates available
- // Colour-resistant
- // Solid and completely coloured
- // Sustainable
- // Material: **GCC**

The figure illustrates the torroTIMBER® bar fence product in terra

** f for structures which are adapted to the slope



A top quality boundary!



Privacy screen fence
"Blickfang" with GCC bar



* The figures illustrate an example of the colours available for delivery and their natural colour maturation process



The strong privacy screen with corrugated panels

Successfully enjoy a degree of privacy and emphasize features with the "Blickfang" privacy screen fence. Its unusual appearance with marbled, corrugated panels immediately catches the eye. The material is colour-resistant and dirt-resistant. The panels almost clean themselves thanks to the vertical position and weathering. Doors and gates can also be suitably integrated and gradients as well as all types of angles can be tackled without any problems whatsoever. Our posts are also extremely durable – we provide you with a 25-year guarantee against rotting in the ground. In short: The perfect boundary option for your garden!

- // Surface: Marbled and corrugated
- // Dimensions: 35 x 270 mm and thickness: 6 mm
- // Length panels: 160.2 cm or 210 cm**
- // Pre-assembly also available for order
- // Matching doors and gates available
- // Colour-resistant and dirt-resistant
- // Solid and completely coloured
- // Sustainable
- // Material: GCC - POWOLIT

** f for structures which are adapted to the slope

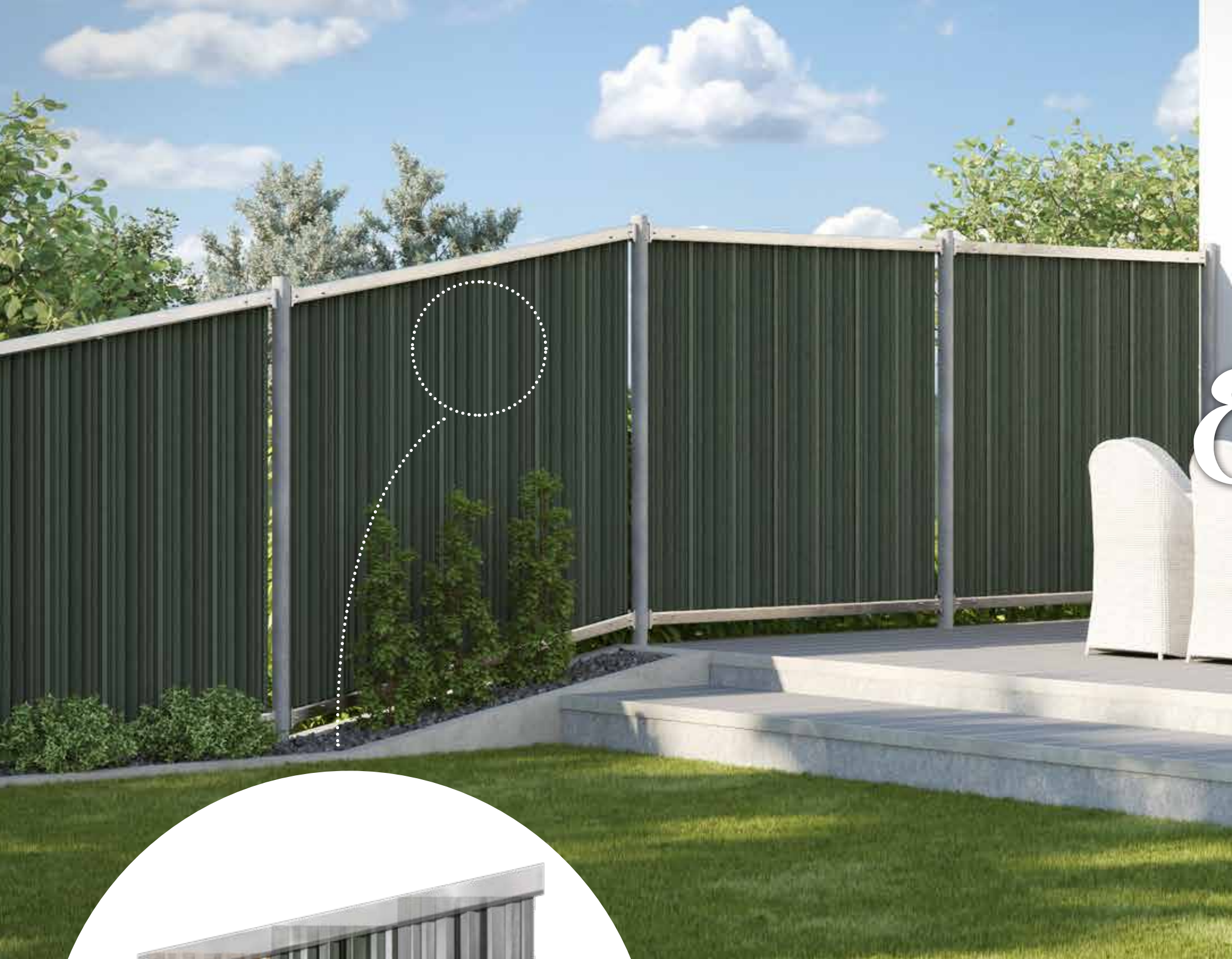

Enjoy privacy!



Privacy screen fence
 "Blickfang" with stainless steel bar

- height and width individually adjustable
- can be erected at all angles
- slope-adapted installation possible
- 25** year guarantee against rotting in the ground
- easier to maintain



GRADIENT OF UP TO 10% WITHOUT A DIAGONAL CUT TO THE PANELS

The modern stainless steel bar in the practical fence field set

No two terrains are the same. The plot may be characterised with various sub-surfaces, gradients, angles or other conditions. In order to make it easier for you to assemble the system, we have developed the fence field set with stainless steel bar. Gradients of up to 10% can be compensated without a diagonal cut to the panels. The stainless steel bar can be quickly assembled and, thanks to the material mix, boasts a modern and smart appearance.

- // One fence field set with stainless steel bar contains: 2 stainless steel bars incl. post fastening, 1 insert bar, 7 panels incl. screws and accessories
- // Posts must be purchased separately
- // Gradients of up to 10% can be compensated without a diagonal cut to the panels
- // Adaptation to the slope
- // Material: **GCC-POWOLIT with stainless steel**

"Blickfang" fence set with new stainless steel bar in Jade



Simply thinking
outside the box!
Simply variable.

**PRE-ASSEMBLY ALSO
AVAILABLE FOR ORDER**

Simple assembly for all fence designs

This torroTIMBER® construction manual is the basis for all versions of fence assembly.

Only use original torroTIMBER® items and simply follow our processing recommendations to ensure that our warranty does not become void.

torroTIMBER® fences can be adapted to individual requirements via the online planner. In order to ensure that assembly is easy, we can pre-assemble all elements on your behalf if requested. This means that you do not need to perform the time-consuming pre-drilling of required holes or adaptations of diagonal section and you can simply start with the assembly! Simply plan your individual fence online at: planner.torrotimber.com/blickfang/en

Setup could not be any easier

- // When mounting by screwing onto the base plate, only use posts with a length of 2.20 m. The maximum construction height of 2 m (upper edge of the floor to the upper edge of the post) may not be exceeded. Caution: Higher structures do not correspond with the static requirements.
- // Holes are to be pre-drilled 0.5 mm smaller than the screw diameter. In order to ensure a full seating, sink the drill-holes for bar connectors. Ensure that the clearance from the edge is at least 10 mm.

- // When mounting the posts and the bar, ensure that you keep to a clearance of 12 mm so that the construction is able to expand without pressure if necessary.
- // The full engagement of the bar connectors when performing the final assembly ensures complete stability.
- // Assembly and production-related tolerances regarding length, width and thickness are to be taken into account during assembly and the dimensions on the construction must be examined once again.

Installation which is adapted to the slope

Gradients in the terrain? Not a problem for the torroTIMBER® privacy screen or the torroTIMBER® bar fence. The torroTIMBER® system sizes can be installed on inclines measuring up to 3%. When dealing with gradients below 10%, use the special lengths or the **fence field set with stainless steel bar**. Greater differences in height in the terrain can be individually adapted by **diagonal cuts to the bar and on the element**.



Angle structure

The oval torroTIMBER® post shape and the innovative bar connector allow the bar fence and privacy screen to be positioned with a free choice of angle.



Anchoring options

torroTIMBER® posts are durable, even when installed in the ground. We offer you a 25 year guarantee against rotting. You can choose between encasing the posts in concrete or on base plates.

Simply encase the posts into concrete

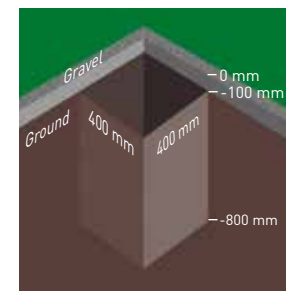

Dig all of the foundation holes (400 x 400 x 800 mm).

Simply assemble the posts on the base plate

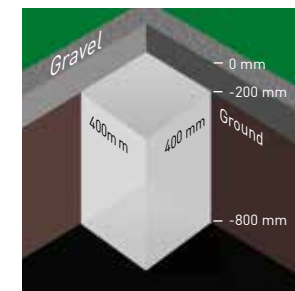

A separate, suitable foundation is required. For this purpose, dig all of the foundation holes (400 x 400 x 800 mm) and fill with concrete to a height of between -800 mm and -200 mm. Allow to fully harden. Alternatively, a suitable anchoring system can be installed on-site.

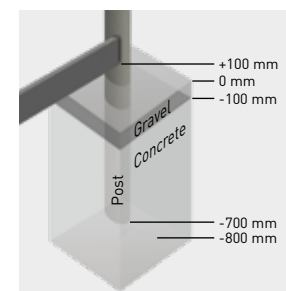

Fill the foundation hole with concrete to a depth of 100 mm. Position the frame in the foundation hole at a depth of -700 mm. Precisely apply the lower edge of the post with the aid of a small brick. Apply concrete into the foundation hole to a level of -100 mm. All posts must be vertically aligned.

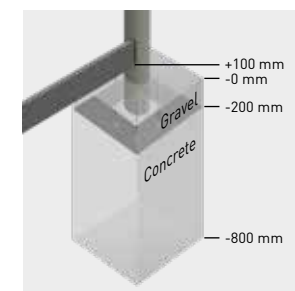

Pre-drill the holes on the post for the base plate (75 x 850 mm). Screw the base plate to the oval post (3 M8 x 80). Fasten the base plate complete with post to the foundation using a suitable anchoring system. All posts must be vertically aligned.

Assembly process of the "Blickfang" privacy screen fence

1 150 cm from the bottom edge of the bar connector to the top edge of the post
With a stainless steel bar: 124 mm between the bottom edge of the bar connector to the top edge of the post
1738 mm between the bottom edge of the top bar connector and the bottom edge of the bottom bar connector
With a stainless steel bar: 1790 mm between the bottom edge of the top bar connector and the bottom edge of the bottom bar connector

2 Attention: Do not fully engage the top bar!
Alternative stainless steel bar

3 Positional fixing with auxiliary objects. (not included in the scope of delivery)

4 6.5 x 30 mm
20 x 3 mm
1626 mm

5 Possible fastening points for panel holders

6

7 **7a** Stainless steel bar

8

9

10 **10a** Stainless steel bar

11 1626 mm clearance between the bottom bar edge (top bar) and the top bar edge (bottom bar)

11a 1810 mm
Clearance of 1730 mm
Stainless steel bar

The frame construction

1. Screw the "Post" connecting part to the post. On the frontal sides of the bar, centrally position and screw the "bar" connecting part. Using a 5.5 mm drill, pre-drill and countersink the holes to 35 mm. (The bar connectors on the stainless steel bar have already been pre-assembled.)
2. Fully engage the lower bar on the post. Apply but do not fully engage the top bar!
3. Position the pre-assembled frame and vertically fasten in the foundation (encased in concrete/screwed). See anchoring options. Prepare all further frames. In order to do so, screw the "Post" connecting part to the next post. Centrally position and mark the "bar" connecting part to the frontal sides of the bar. Using a 5.5 mm drill, pre-drill and countersink the holes to 35 mm and screw into place. Vertically fasten the post in the foundation, fully engage the bottom bar and apply the top bar.

Simple panel assembly with the GCC bar

4. Remove the upper fence bar. When dealing with the side panel holder, pre-drill the hole to a depth of 30 mm (6.5 mm drill) in the centre of the post and countersink to a depth of 3 mm (20 mm) drill. Fasten the panel holder (please see detail).
5. Insert the first panel into the side panel holder and determine the lower drill hole in the bar for the lower panel holder, then mark and pre-drill. Apply the lower panel holder to left or right hand side of the first panel at the centre of the highest corrugation. Insert the panel complete with panel holder (please see detail).

6. Determine the next drilling location and pre-drill to a depth of 25 mm (using a 6.5 mm drill).
7. Connect the further panels by inserting into the previous panel and fasten with a lower panel holder.
8. Insert further panels. When dealing with the last panel, pay attention to the additional side fastening with the panel holder (see detail 4).
9. Equip the upper edge of the panel with the panel holders and apply the upper bar but do not fully engage. Precisely mark the position of the drill holes for the upper panel holder and pre-drill to a depth of 25 mm (6.5 mm drill).
10. Apply the top bar and fully engage.
11. Assemble the next fence section in the same manner.

The alternative assembly with stainless steel bar

- 7a Place the insert bar into the lower stainless steel bar (in the event of horizontal structure) in order to align the height of the panels. They can now be positioned.
- 10a Connect the panels by inserting into the respective previous panel. (Attention: When dealing with the stainless steel bar, panels with a special length of 180.5 cm are used) Apply the upper stainless steel bar and fully engage. Using a threaded pin and cap nut, fasten the first and last panel to the lower and upper bar (the holes in the bar have been pre-drilled).
- 11a Assemble the next fence section in the same manner.

Please use our fence configurator that is available online at torrotimber.com/blickfang for individual structures, e.g. inclined adaptation to the slope.

Article overview for the assembly of the „Blickfang“ privacy screen fence

25 year guarantee against rotting in the ground

Post
Dimensions: 60 x 90 mm
Colours: Terra and Graphite
Lengths: 220 cm, 270 cm (available in a 360 cm version for structures which are adapted to the slope)

Panel
Dimensions: 35 x 270 mm
Length: 160.2 cm (available in a 210 cm version for structures which are adapted to the slope)
Thickness: 6 mm
Colours: Jade, Ecru and Platin
Requirement: 7 units per field

Door and gate
Dimensions: 102 x 185 cm (Frame: 112 x 270 cm)
Colours: Frame: Terra and graphite
Panels: Jade, Ecru and Platin
incl. fittings, pre-aligned for profile cylinders
Production available on request
Attention: Connect the frame to the post in a force-locking manner using 5 M8 x 80 fastening screws per side, connect and then encase into concrete together.

Fence set with stainless steel bar
Gradient of up to 10% without a diagonal cut to the panels
Set for 1 fence contains:
2 stainless steel bars
incl. post fastening
1 insert bar
7 panels (Jade, Ecru or Platin)
incl. screws and accessories
Posts are available separately. Can also be combined with all other post system types.

Panel holder
Requirement: 16 units per field
Material: Stainless steel

Bar
Dimensions: 40 x 112 mm
Colours: Terra and Graphite
Length: 178.6 cm (available in a 360 cm version for structures which are adapted to the slope)

Bar connector, two-part
Post/bar
Requirement: 2 parts per bar
Material: Blackened stainless steel incl. 4 screws (M6 x 30 mm) per connector

Base plate - post
Dimensions: 120 x 120 mm
Requirement: 1 unit per post
Material: Steel galvanised
Thickness: 8 mm
incl. 3 fastening screws (M8 x 80 mm) per plate

Bar fence assembly procedure

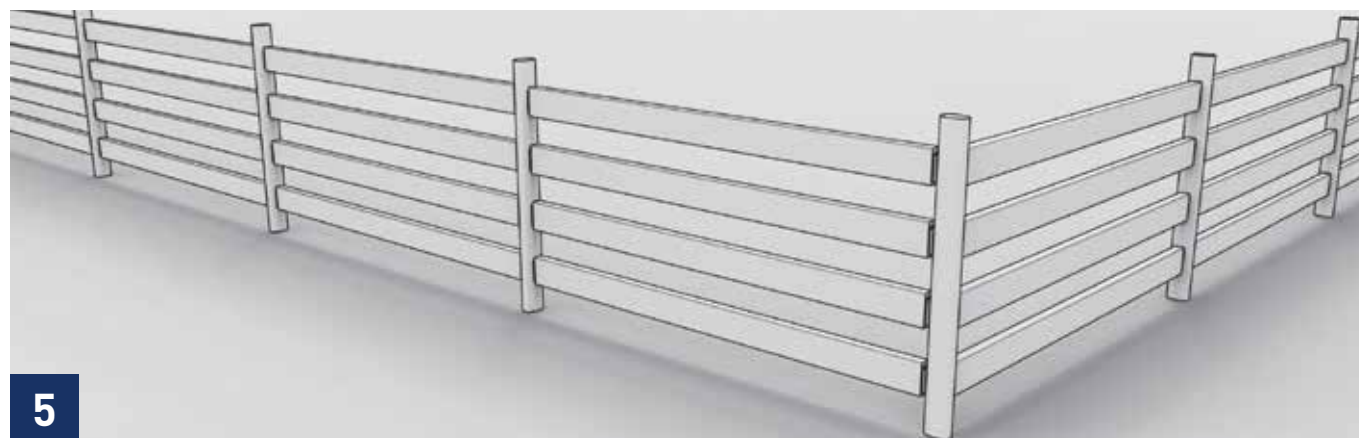
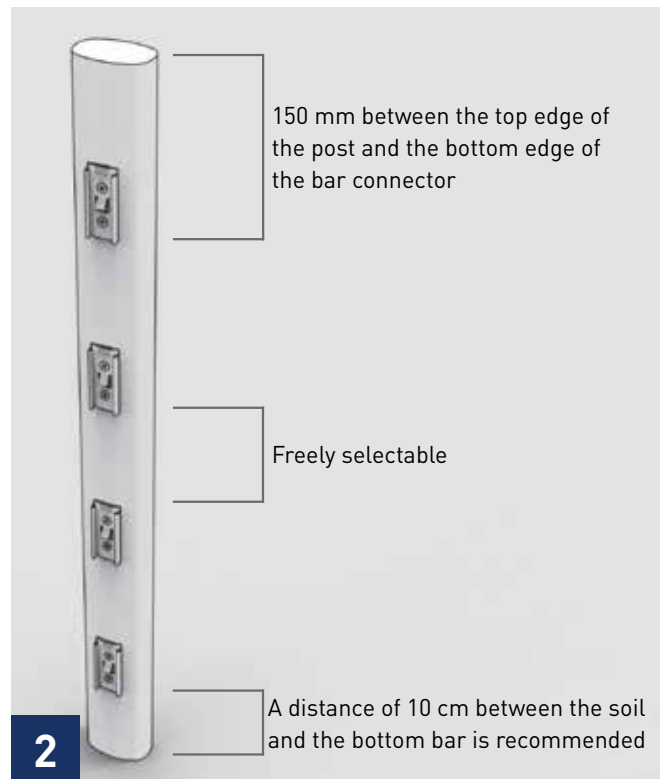
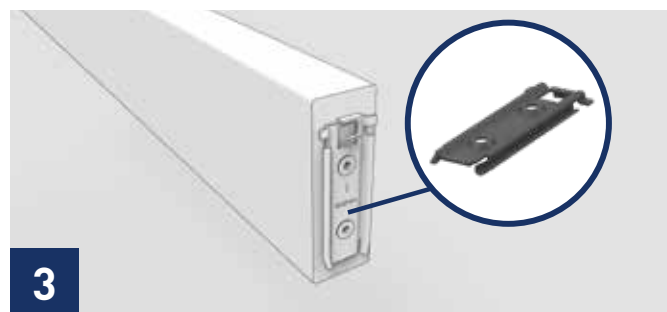
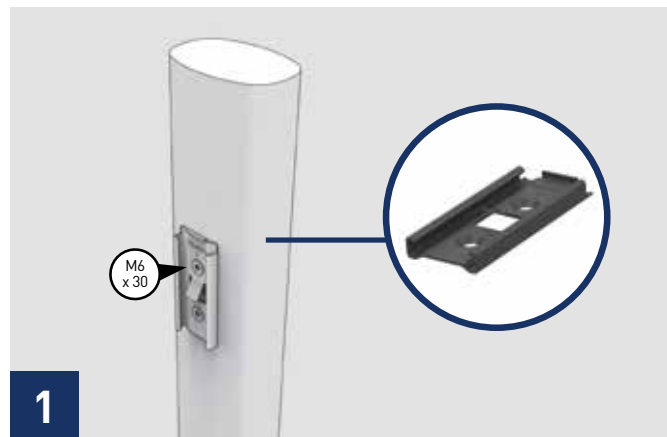

1. Screw the "Post" connecting part to the post. Pay attention to the "TOP" labelling. Using a 5.5 mm drill, pre-drill and countersink the holes to 35 mm.
2. Screw the "Post" connecting part to the post at equally spaced intervals. Please note that the bottom fence bar has a gap measuring at least 100 cm to the ground.
3. Centrally position, mark, countersink and screw the "Bar" connecting part to the frontal sides of the bar.
4. Insert the bottom and top bars but do not fully engage the top bar.
5. Position the pre-assembled frame and vertically concrete/screw into the foundation. Please see Anchoring options. Once the concrete has set or after the screwing process has been completed, remove the top bar, insert all of the missing bars from beneath and fully engage.



A material for
the future.
A material that
lasts the course.



Imprint



Publisher:

NOVO-TECH Trading GmbH & Co. KG
Siemensstraße 31, 06449 Aschersleben, Germany

Concept/design/layout/images:

FULLHAUS GmbH, Regensburg

Subject to change.

We assume no liability for printing errors.

**Colours and graphics may differ from the original
due to technical reasons.**

Date:

January 13, 2021 // 1st version

Your dealer

